

# V27, K5.6

Residential Horizontal Sidewall, Recessed Horizontal Sidewall

## V2744 QUICK RESPONSE

The Model V2744 residential sprinkler is designed with optimal flow characteristics for use in residential NFPA 13 systems. The larger 5.6 K-Factor will aid in the system design where higher flows are required. The V2744 is also listed for use in wet pipe systems per NFPA 13D and 13R under smooth, flat, horizontal ceilings. The design incorporates state-of-the-art, heat responsive, frangible glass bulb design (quick response) for prompt, precise operation.

The die cast frame is more streamlined and attractive than traditional sand cast frames. It is cast with a hex-shaped wrench boss to allow easy tightening from many angles, reducing assembly effort. This sprinkler is available in various finishes to meet many design requirements.



SEE VICTAULIC PUBLICATION 10.01 FOR DETAILS



RECESSED HORIZONTAL SIDEWALL

### SPRINKLER OPERATION:

The operating mechanism is a frangible glass bulb which contains a heat responsive liquid. During a fire, the ambient temperature rises causing the liquid in the bulb to expand. When the ambient temperature reaches the rated temperature of the sprinkler, the bulb shatters. As a result, the waterway is cleared of all sealing parts and water is discharged towards the deflector. The deflector is designed to distribute the water in a pattern that is most effective in controlling the fire.

### COVERAGE:

Residential spray coverage up to 16 x 20 feet/4.9 x 6.1 m room sizes per NFPA.

**These sprinklers meet the requirements of UL 1626.**

### TECHNICAL SPECIFICATIONS:

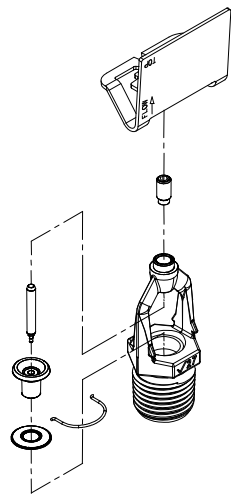

Exaggerated for clarity

**Models:** V2744

**Style:** Residential Horizontal Sidewall and Recessed Horizontal Sidewall

**Nominal Orifice Size:** 1/2" / 13mm

**K-Factor:** 5.6 Imp./8.1 S.I.

**Nominal Thread Size:** 1/2" NPT / 13mm

**Max. Working Pressure:** 175 psi / 1200 kPa

**Factory Hydrostatic Test:**

100% @ 500 psi / 3450 kPa

**Min. Operating Pressure:** 5 psi / 34 kPa

**Temperature Rating:** See chart on page 2

#### MATERIAL SPECIFICATIONS

**Pendent Deflector:** Bronze per UNS C51000

**Bulb:** Glass with glycerin solution.

**Bulb Nominal Diameter:**

- Quick Response: 3.0mm

**Load Screw:** Bronze per UNS C65100

**Pip Cap:** Bronze per UNS C65100

**Seal:** Teflon\* tape

**Frame:** Die cast brass 65-30

### ACCESSORIES

#### Installation Wrench:

- Open End: V27
- Recessed: V27-2

#### Sprinkler Finishes:

- Plain brass
- Chrome plated
- White painted\*\*
- Custom painted\*\*

For escutcheons, cabinets and other accessories refer to separate sheet.

^ For K-Factor when pressure is measured in Bar, multiply S.I. units by 10.0.

\* Teflon is a registered trademark of Dupont Co.

\*\* UL Listed for corrosion resistance in all configurations.

NOTE: Weather resistant recessed escutcheon available upon request.

### JOB/OWNER

System No. \_\_\_\_\_

Location \_\_\_\_\_

### CONTRACTOR

Submitted By \_\_\_\_\_

Date \_\_\_\_\_

### ENGINEER

Spec Sect \_\_\_\_\_ Para \_\_\_\_\_

Approved \_\_\_\_\_

Date \_\_\_\_\_

www.victaulic.com

VICTAULIC IS A REGISTERED TRADEMARK OF VICTAULIC COMPANY. © 2013 VICTAULIC COMPANY. ALL RIGHTS RESERVED.

REV\_D



## V27, K5.6

Residential Horizontal Sidewall, Recessed Horizontal Sidewall

### V2744 QUICK RESPONSE

#### APPROVALS/LISTINGS

Model	Orifice Size	Nominal K-Factor	Response	Deflector Type	Approved Temperature Ratings ‡ @
	Inches mm	Imperial S.I.^	Standard or Quick		
V2744	½ 13	5.6 8.1	Quick	Horizontal Sidewall	1, 2, 3 – A
V2744	½ 13	5.6 8.1	Quick	Recessed Horizontal Sidewall Up to ¾" Adjustment	1, 2, 3 – A

^ For K-Factor when pressure is measured in Bar, multiply S.I. units by 10.0.

‡ Listings and approval as of printing.

#### APPROVED TEMPERATURE RATINGS

Approval	Temperature Rating
1 – CULUS	A – 155°F/68°C, 175°F/79°C
2 – NYC/MEA	
3 – CSFM	

DISCONTINUED SUBMITTAL:  
REFERENCE <https://www.victaulic.com/assets/uploads/sprinklers>  
FOR OUR CURRENT OFFERING AND APPLICABLE SUBMITTALS

**V27, K5.6**

Residential Horizontal Sidewall, Recessed Horizontal Sidewall

**V2744 QUICK RESPONSE**

**RATINGS**

All glass bulbs are rated for temperatures from -67°F/-55°C to those shown in table below.

Sprinkler Temperature Classification	Victaulic Part Identification	Temperature – °F/°C		Glass Bulb Color
		Nominal Temperature Rating	Maximum Ambient Temperature Allowed	
Ordinary	C	155	100	Red
		68	38	
Intermediate	E	175	150	Yellow
		79	65	

**ORDERING INFORMATION**

Please specify the following when ordering:





Sprinkler Model Number	
Style	
Temperature Rating	
K-Factor	
Thread Size	
Quantity	
Sprinkler Finish	
Escutcheon Finish	
Wrench Model Number	

## V27, K5.6

Residential Horizontal Sidewall, Recessed Horizontal Sidewall

### V2744 QUICK RESPONSE



 <b>WARNING</b>	
    	<ul style="list-style-type: none"> <li>Always read and understand installation, care, and maintenance instructions, supplied with each box of sprinklers, before proceeding with installation of any sprinklers.</li> <li>Always wear safety glasses and foot protection.</li> <li>Depressurize and drain the piping system before attempting to install, remove, or adjust any Victaulic piping products.</li> <li>Installation rules, especially those governing obstruction, must be strictly followed.</li> <li>Painting, plating, or any re-coating of sprinklers (other than that supplied by Victaulic) is not allowed.</li> </ul> <p>Failure to follow these instructions could result in serious personal injury and/or property damage.</p> <p>The owner is responsible for maintaining the fire protection system and devices in proper operating condition. For minimum maintenance and inspection requirements, refer to the current National Fire Protection Association pamphlet that describes care and maintenance of sprinkler systems. In addition, the authority having jurisdiction may have additional maintenance, testing, and inspection requirements that must be followed.</p> <p>If you need additional copies of this publication, or if you have any questions about the safe installation of this product, contact Victaulic World Headquarters: P.O. Box 31, Easton, Pennsylvania 18044-0031 USA, Telephone: 001-610-559-3300.</p>

DISCONTINUED  
 REFERENCE <https://www.victaulic.com/downloads/sprinklers>  
 FOR OUR CURRENT OFFERING AND APPROPRIATE SUBMITTALS

**V27, K5.6**

Residential Horizontal Sidewall, Recessed Horizontal Sidewall

**V2744 QUICK RESPONSE**

**DIMENSIONS**

**Standard – V2744**

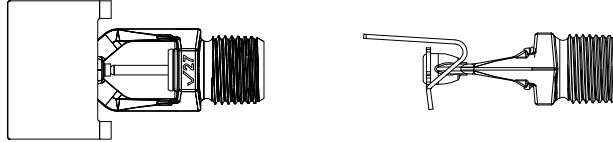

**1/2" Adjustment Recessed – V2744 (drawing not to scale)**

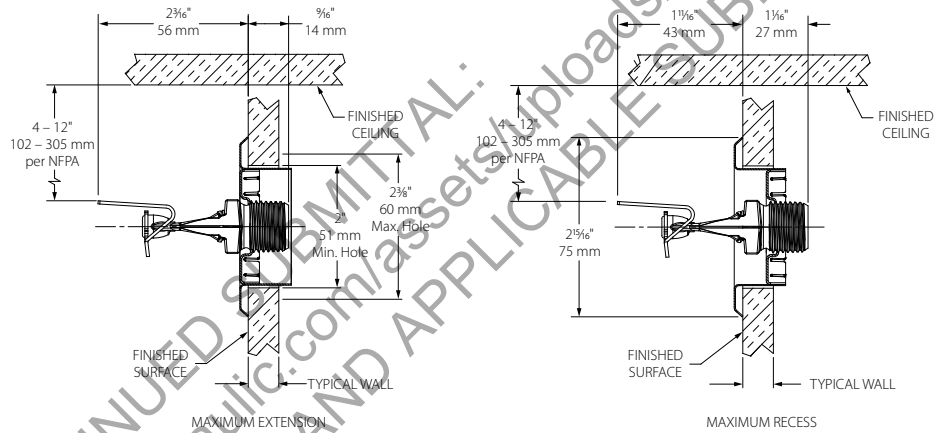

**3/4" Adjustment Recessed – V2744 (drawing not to scale)**

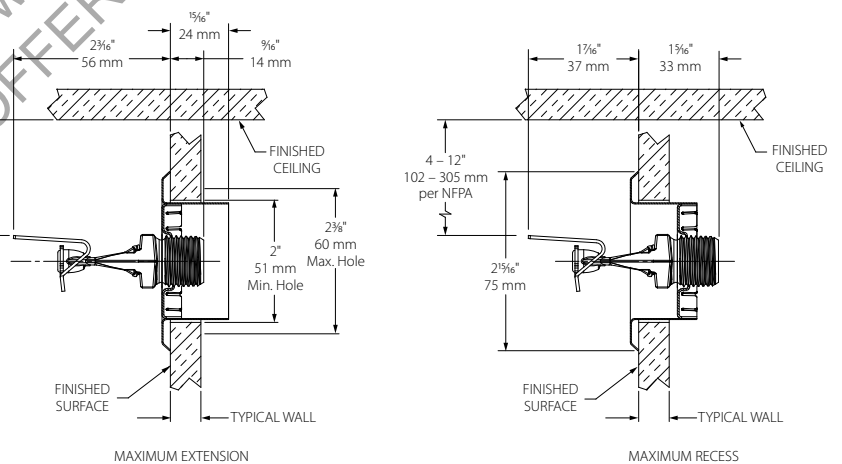

# V27, K5.6

Residential Horizontal Sidewall, Recessed Horizontal Sidewall

## V2744 QUICK RESPONSE

### AVAILABLE WRENCHES

Sprinkler Type	Wrenches
V2744 Residential Horizontal Sidewall	V27
V2744 Residential Horizontal Recessed Sidewall	V27-2

### ROOM SIZE

Victaulic V2744, 5.6 K-Factor Horizontal Sidewall Sprinkler  
For Ceiling types refer to NFPA 13, 13R or 13D 2013 Editions

Max. Coverage Area <sup>(a)</sup> Width X Length <sup>(c)</sup>	Max. Spacing	Ordinary Temp Rating 155°F/68°C		Intermediate Temp Rating 175°F/79°C		Top of Deflector to Ceiling	Installation Type	Minimum Spacing	
		Flow <sup>(b)</sup> GPM L/min	Pressure <sup>(b)</sup> PSI bar	Flow <sup>(b)</sup> GPM L/min	Pressure <sup>(b)</sup> PSI bar				
12 X 12 3.7 X 3.7	12 3.7	15 56.8	7.2 0.5	15 56.8	7.2 0.5	4 to 6 inches	¾" recessed using Escutcheon or non-recessed per NFPA 13, 13R or 13D	8.0 2.4	
14 X 14 4.3 X 4.3	14 4.3	19 71.9	11.5 0.8	19 71.9	11.5 0.8				
16 X 16 4.9 X 4.9	16 4.9	23 87.1	16.9 1.6	23 87.1	16.9 1.6				
16 X 18 4.9 X 5.5	16 4.9	25 94.6	19.9 1.4	25 94.6	19.9 1.4				
16 X 20 4.9 X 6.1	16 4.9	30 113.6	28.7 1.98	30 113.6	28.7 1.98				
12 X 12 3.7 X 3.7	12 3.7	17 64.4	9.2 0.63	17 64.4	9.2 0.63	6 to 12 inches		¾" recessed using Escutcheon or non-recessed per NFPA 13, 13R or 13D	8.0 2.4
14 X 14 4.3 X 4.3	14 4.3	22 83.3	15.4 1.06	22 83.3	15.4 1.06				
16 X 16 4.9 X 4.9	16 4.9	27 102.2	23.2 1.6	27 102.2	23.2 1.6				
16 X 18 4.9 X 5.5	16 4.9	31 117.3	30.6 2.11	31 117.3	30.6 2.11				
16 X 20 4.9 X 6.1	16 4.9	37 140.1	43.6 3.01	37 140.1	43.6 3.01				

(a) For coverage area dimensions less than or between those indicated, use the minimum required flow for the next highest coverage area for which hydraulic design criteria are stated.

(b) For NFPA 13 residential applications, the greater of 0.1gpm/ft<sup>2</sup> over the design area of the flow in accordance with the criteria in the table must be used.

(c) The Width X Length dimension refers to the Width (backwall where the sprinkler is located) times the Length (horizontal throw of sprinkler)

V27, K5.6

Residential Horizontal Sidewall, Recessed Horizontal Sidewall  
**V2744 QUICK RESPONSE**

**NOMINAL WETTING PATTERNS**

**Model V2744**

**K5.6 Residential Horizontal Sidewall and Recessed Horizontal Sidewall**

15 GPM/56.8 LPM – 12' x 12'/3.7 x 3.7 m coverage area – 4"/101.6 mm from ceiling

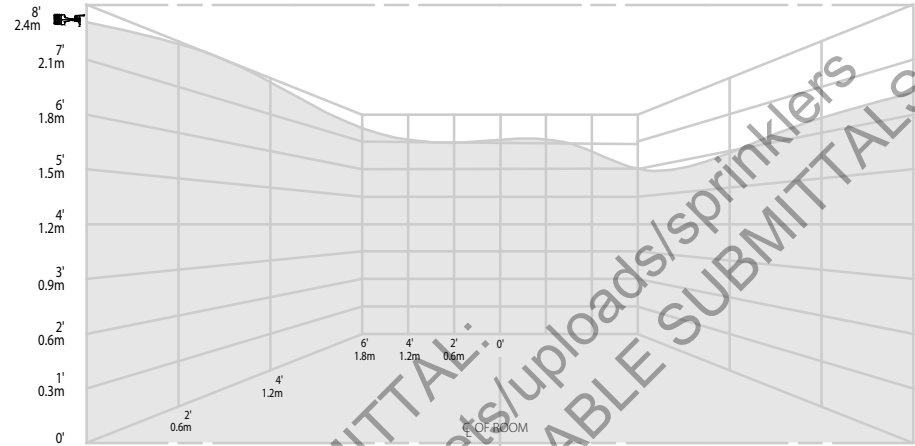

**Model V2744**

**K5.6 Residential Horizontal Sidewall and Recessed Horizontal Sidewall**

17 GPM/64.3 LPM – 12' x 12'/3.7 x 3.7 m coverage area – 12"/304.8 mm from ceiling

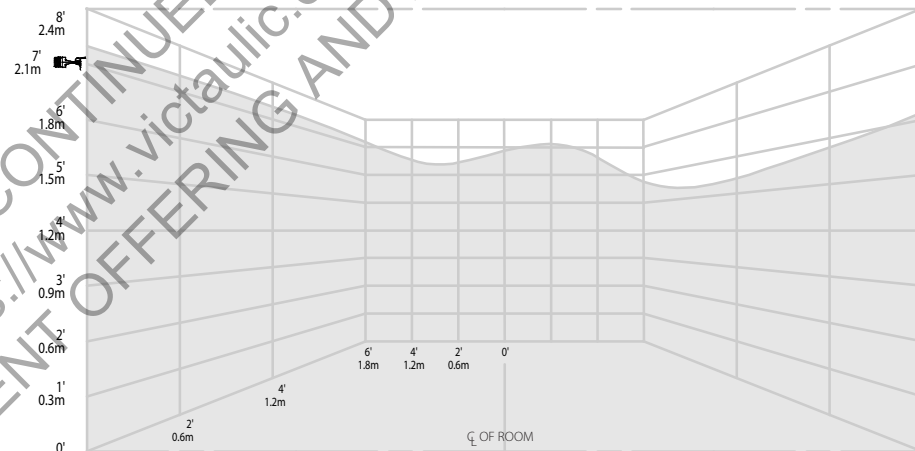

See notes on page 11.

# V27, K5.6

Residential Horizontal Sidewall, Recessed Horizontal Sidewall

## V2744 QUICK RESPONSE

### NOMINAL WETTING PATTERNS

#### Model V2744

#### K5.6 Residential Horizontal Sidewall and Recessed Horizontal Sidewall

19GPM/71.9LPM – 14' x 14'/4.3 x 4.3m coverage area – 4"/101.6mm from ceiling

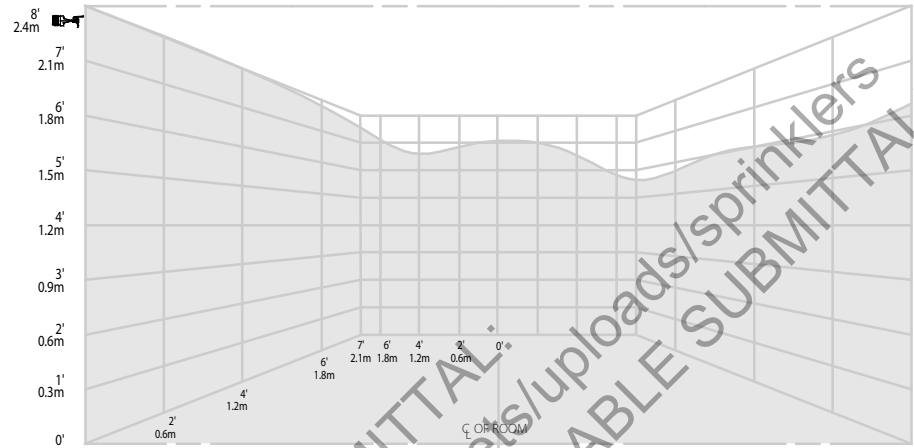

#### Model V2744

#### K5.6 Residential Horizontal Sidewall and Recessed Horizontal Sidewall

22GPM/83.3LPM – 14' x 14'/4.3 x 4.3m coverage area – 12"/304.8mm from ceiling

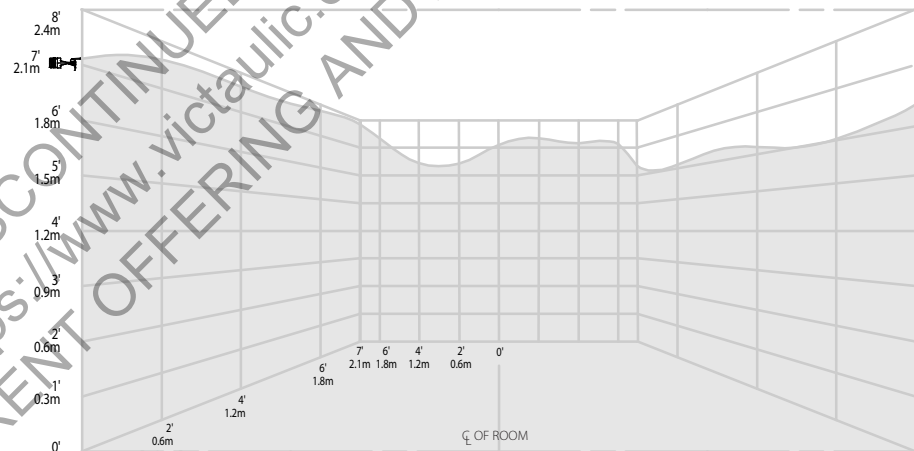

See notes on page 11.

V27, K5.6

Residential Horizontal Sidewall, Recessed Horizontal Sidewall  
**V2744 QUICK RESPONSE**

**NOMINAL WETTING PATTERNS**

**Model V2744**

**K5.6 Residential Horizontal Sidewall and Recessed Horizontal Sidewall**

23 GPM/87.1 LPM – 16' x 16'/4.9 x 4.9m coverage area – 4"/101.6mm from ceiling

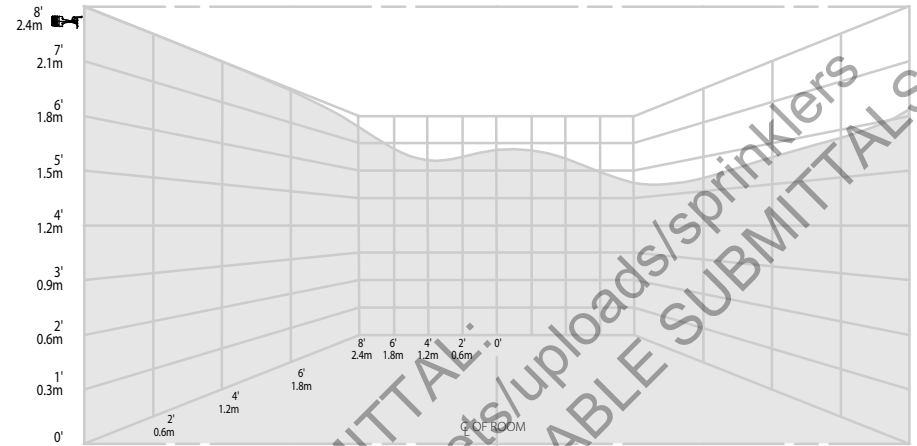

**Model V2744**

**K5.6 Residential Horizontal Sidewall and Recessed Horizontal Sidewall**

27 GPM/102.2 LPM – 16' x 16'/4.9 x 4.9m coverage area – 12"/304.8mm from ceiling

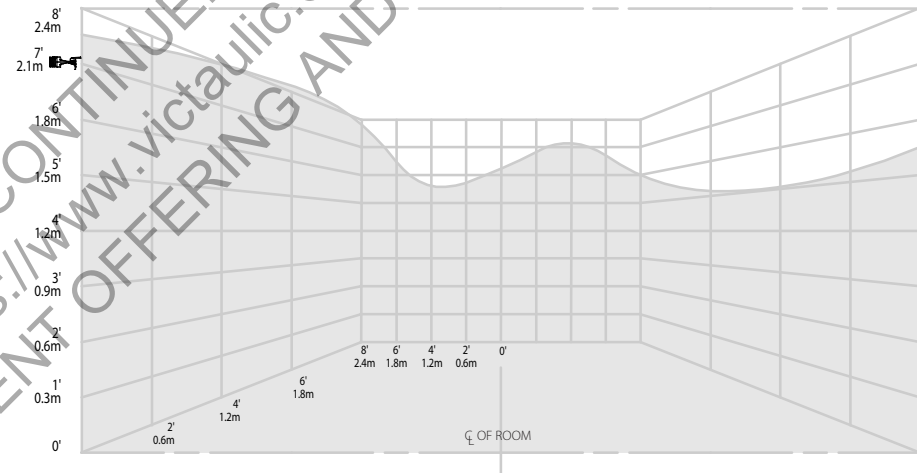

See notes on page 11.

# V27, K5.6

Residential Horizontal Sidewall, Recessed Horizontal Sidewall

## V2744 QUICK RESPONSE

### NOMINAL WETTING PATTERNS

#### Model V2744

#### K5.6 Residential Horizontal Sidewall and Recessed Horizontal Sidewall

25 GPM/94.6 LPM – 16' x 18'4.9 x 5.5 m coverage area – 4" / 101.6 mm from ceiling

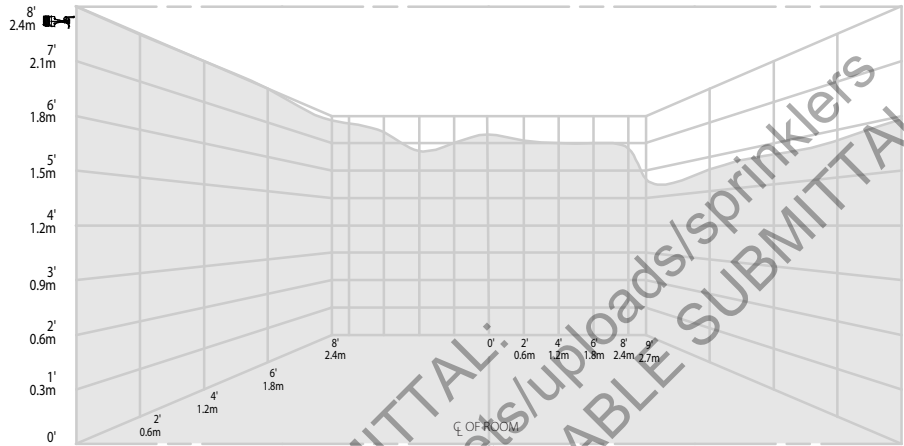

#### Model V2744

#### K5.6 Residential Horizontal Sidewall and Recessed Horizontal Sidewall

31 GPM/117.3 LPM – 16' x 18'4.9 x 5.5 m coverage area – 12" / 304.8 mm from ceiling

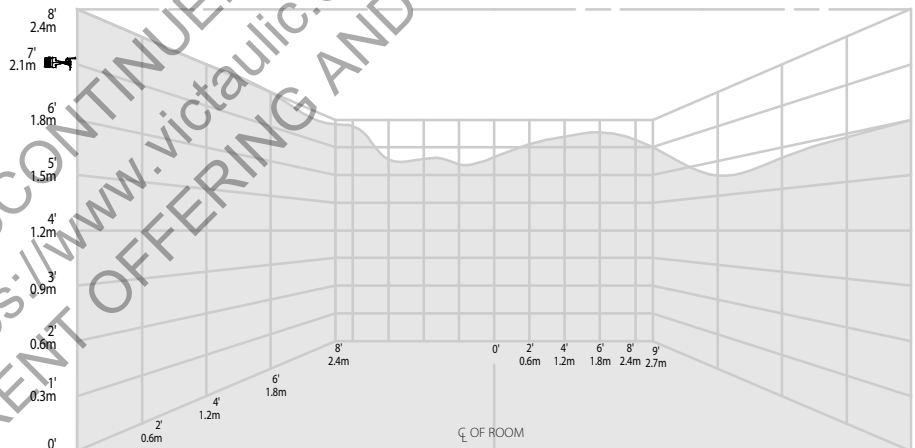

See notes on page 11.

V27, K5.6

Residential Horizontal Sidewall, Recessed Horizontal Sidewall

V2744 QUICK RESPONSE

NOMINAL WETTING PATTERNS

Model V2744

K5.6 Residential Horizontal Sidewall and Recessed Horizontal Sidewall

30 GPM/113.5 LPM – 16' x 20'4.9 x 6.1 m coverage area – 4" / 101.6 mm from ceiling

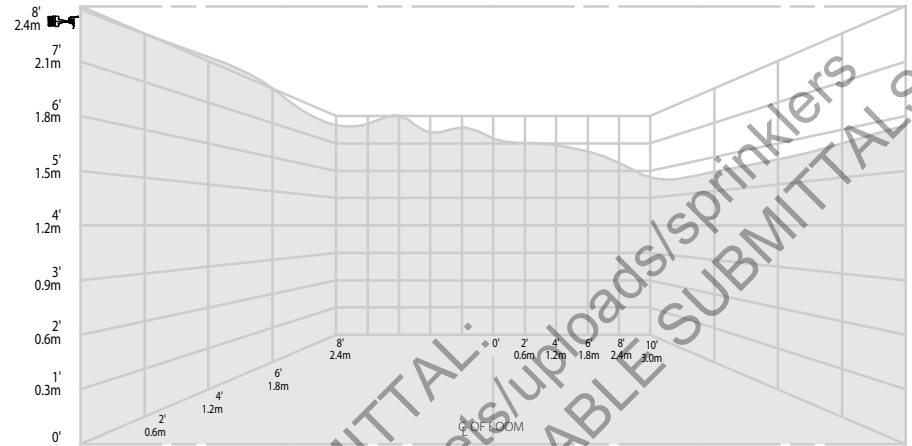

Model V2744

K5.6 Residential Horizontal Sidewall and Recessed Horizontal Sidewall

37 GPM/140.0 LPM – 16' x 20'4.9 x 6.1 m coverage area – 12" / 304.8 mm from ceiling

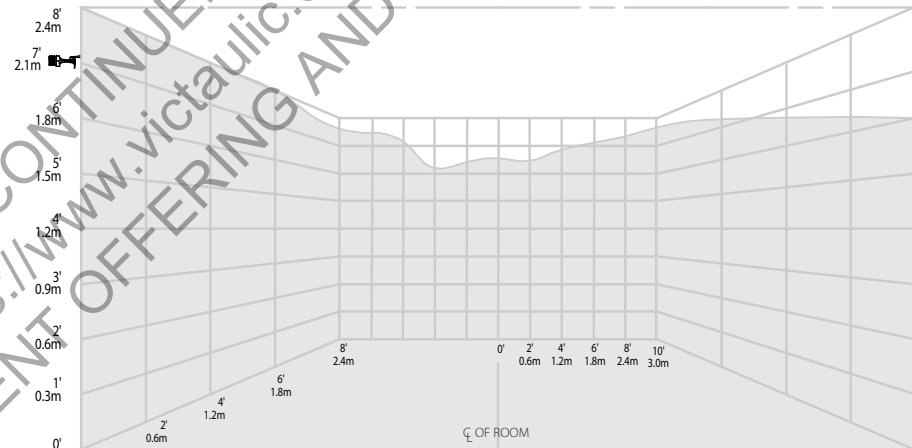

NOTES:

- 1 Data shown is approximate and can vary due to differences in installation.
- 2 These graphs illustrate approximate wall-wetting patterns for these specific Victaulic FireLock Automatic Sprinklers. They are provided as information for guidance and should not be used as minimum sprinkler spacing rules for installation. Sprinkler location shall be in accordance with the obstruction rules for residential sprinklers in NFPA 13 (2002 or later revision). Failure to follow these guidelines could adversely affect the performance of the sprinkler and will void all Listings, Approvals and Warranties.
- 3 All patterns are symmetrical to waterway.

## V27, K5.6

Residential Horizontal Sidewall, Recessed Horizontal Sidewall

### V2744 QUICK RESPONSE

---

**WARRANTY**

Refer to the Warranty section of the current Price List or contact Victaulic for details.

---

**NOTE**

This product shall be manufactured by Victaulic or to Victaulic specifications. All products to be installed in accordance with current Victaulic installation/assembly instructions. Victaulic reserves the right to change product specifications, designs and standard equipment without notice and without incurring obligations.

DISCONTINUED SUBMITTAL:  
REFERENCE <https://www.victaulic.com/assets/uploads/sprinklers>  
FOR OUR CURRENT OFFERING AND APPLICABLE SUBMITTALS

---

For complete contact information, visit [www.victaulic.com](http://www.victaulic.com)

40.49 4703 REV D UPDATED 04/2013

VICTAULIC IS A REGISTERED TRADEMARK OF VICTAULIC COMPANY. © 2013 VICTAULIC COMPANY. ALL RIGHTS RESERVED.

40.49

